

H97 < B = 5 @ 85 H 5 ' G < 99 H

85 H 1 D 8 5 H 8 .
, # & (# & \$ % +



H#0.
@ C B ; ' 5 D 9 L ' G F I H

D 5 F H B C "
5 D L ! @ G F H

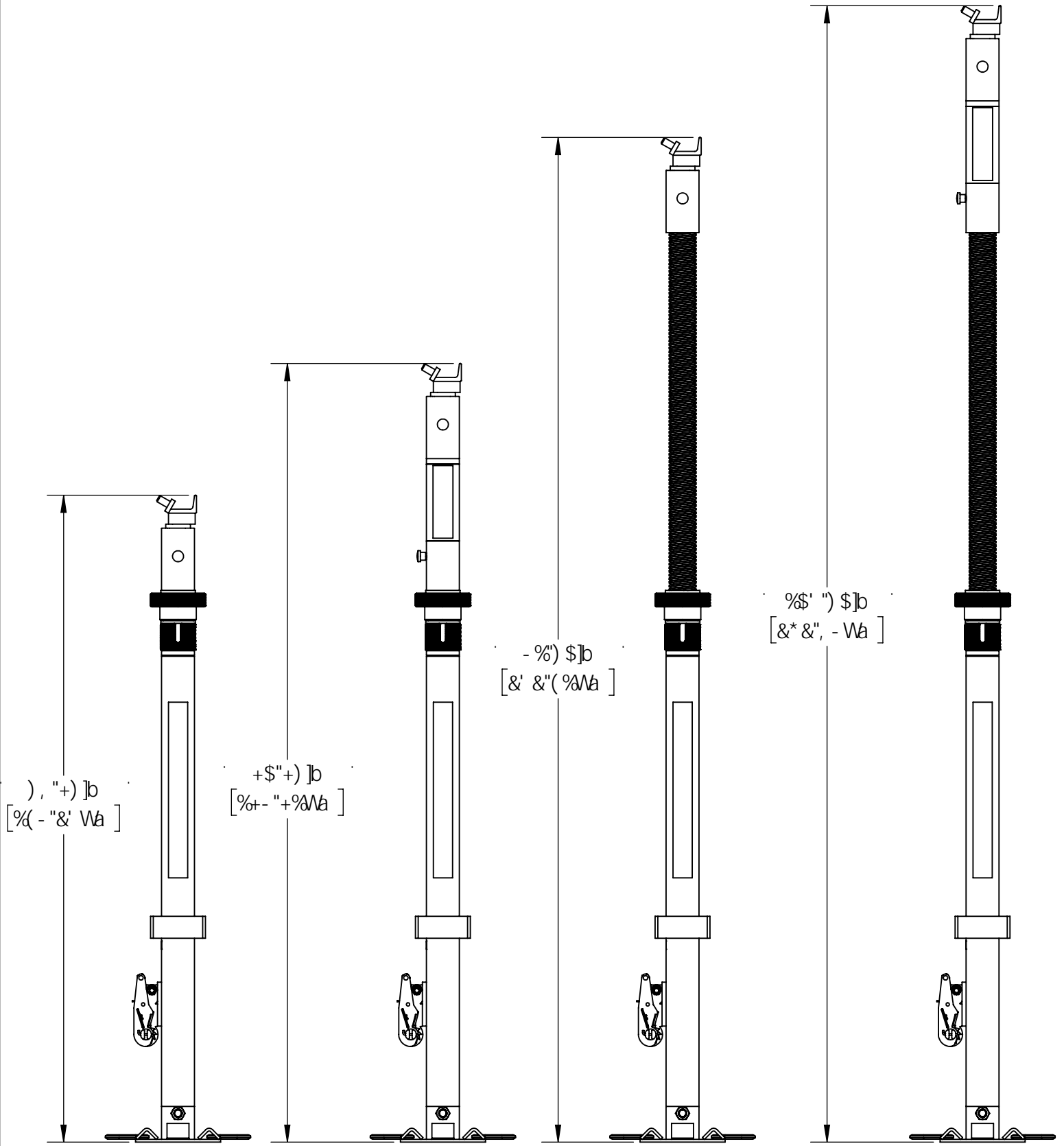

G < 99 H % C : ' "

H97 < B = 7 5 @ 85 H 5 ' G < 99H

85H91 D85H98.
, #&(#&\$%+>



H#0.
@ C B; ' 5 D9L ' G F I H

D5FHBC "
5 DL! @ G F H

| @ 58 ' F 5 H B; ' f & % G 5: 9 H M: 5 7 H C F L | | | | | |
|---|-------------------------|---------------------|-------------------|---------------------|-------------------|
| < 9 ÷ < H f l b l | < 9 ÷ < H f W a L | 7 C @ A B ' f i v g | C :: G9 H f i v g | 7 C @ A B ' f l [g | C :: G9 H f l [g |
| () ! * & ") | % % (" * & ! % , " +) | % & z) \$ \$ | * z \$ \$ |) z * * - | ' z % & - |
| * & ") ! + (") | % , " +) ! % - " & ') | - z (\$ \$ |) z (\$ \$ | (z & * ') | & z ((- |
| + (") ! - %) | % - " & ! & ' & " (%) | + z +) \$ |) z & \$ \$ \$ | ' z) %) | & z) , |
| - %) ! % \$ ' ") | & ' & " (% & * & ' , - |) z (\$ \$ | ' z + \$ \$ | & z ((- | % z * + , |

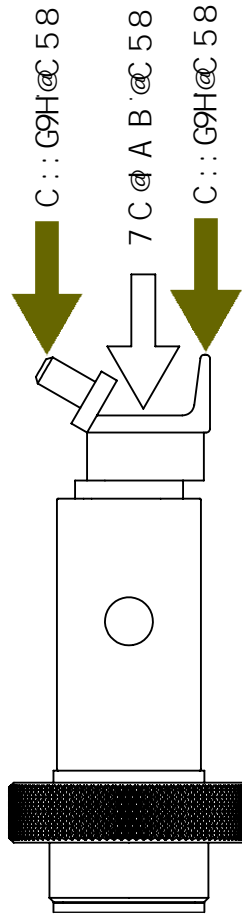

H97 < B = 7 5 @ 85 H 5 ' G < 99H

85H71 D85H98.
, #&(#&\$%+



H#0.
@ C B; ' 5 D9L ' G F I H

D5FHBC "
5 DL! @ G F H

GHC F5; 9

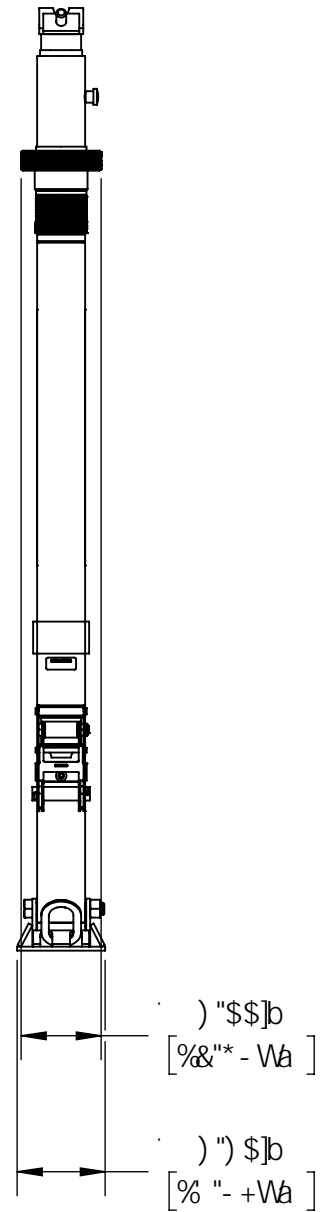
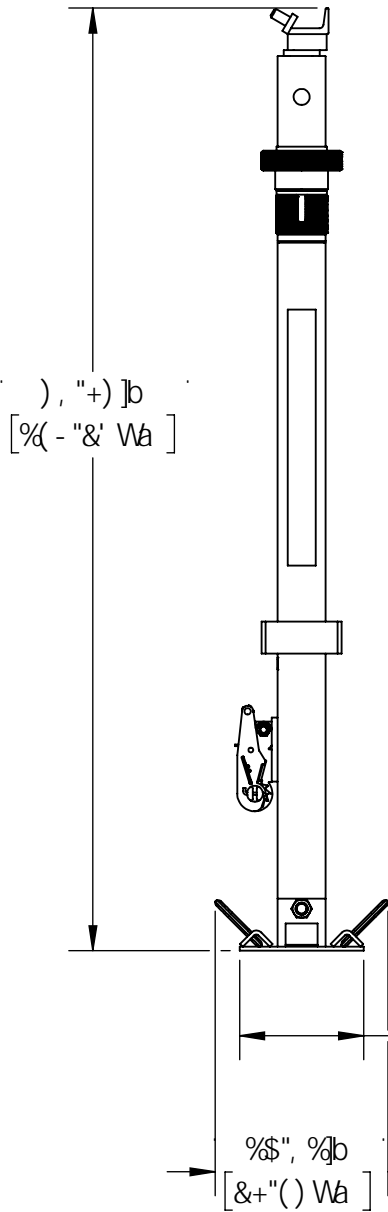

G< 99H' C : "

H97 < B = 5 @ 85 H 5 ' G < 99 H

85 H 1 D 8 5 H 8 .
, # & (# & \$ % +



H # 0 .
G < C F H 5 D 9 L ' G F I H

D 5 F H B C "
5 D L ! G G F H

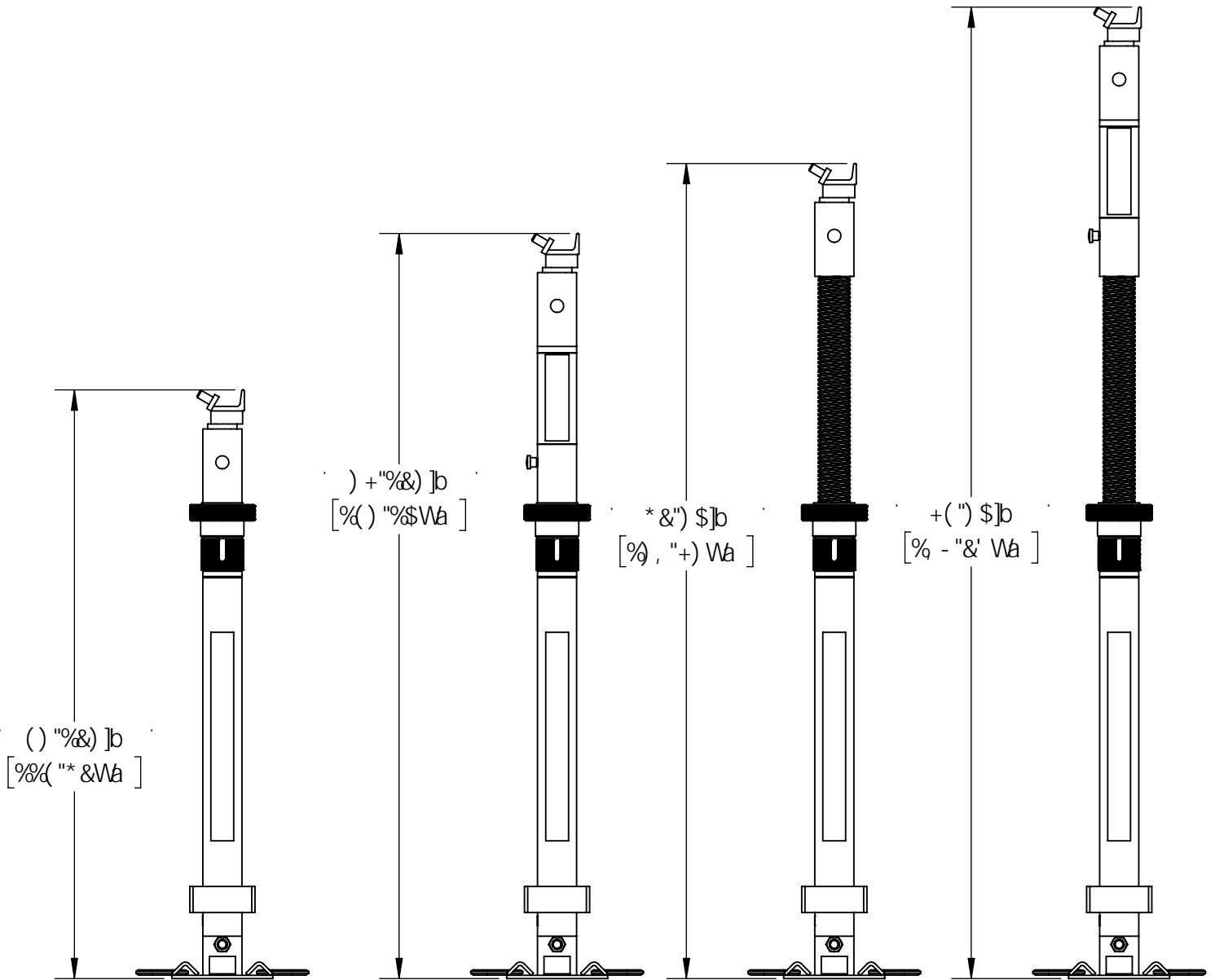

H97 <B=7 5@85H5 'G<99H

85H91 D85H98.
, #&(#&\$%+



H#09.
G<C FH5 D9L 'GF1 H

D5FHBC "
5 DL!GGFH

| @ 58 'F5HB; 'f&.%G5: 9HM: 57 HC FL | | | | | |
|------------------------------------|-------------------------|------------------|---------------|------------------|--------------------|
| <9÷ <Hf]bŁ | <9÷ <HfMa Ł | 7 C @ A B 'fIVgŁ | C :: G9HfIVgŁ | 7 C @ A B 'fIVgŁ | 7 C @ A B 'fI[Ł gŁ |
| () ! * & ") | % % (" * & ! % , " +) | % & ž) \$ \$ | * ž - \$ \$ |) ž * * - | ' ž % & - |
| * & ") ! + (") | % , " +) ! % - " & ') | - ž (\$ \$ |) ž (\$ \$ | (ž & * ') | & ž (- |
| + (") ! - % () | % - " & ' ! & ' & " (% | + ž +) \$ |) ž & \$ \$ | ' ž) % | & ž) , |
| - % () ! % \$ ' ") | & ' & " (% & * & " , - |) ž (\$ \$ | ' ž + \$ \$ | & ž (- | % ž * + , |

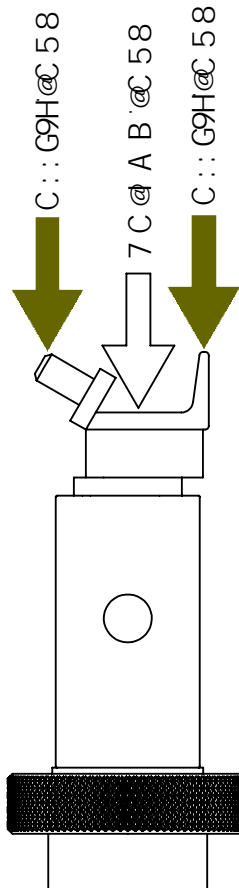

H97 < B = 7 5 @ 85 H 5 ' G < 99H

85H91 D85H98.
, #&(#&\$%+



H#09.
G< C FH5 D9L 'GF1 H

D5FHBC "
5 DL!GGFH

GHC F5; 9

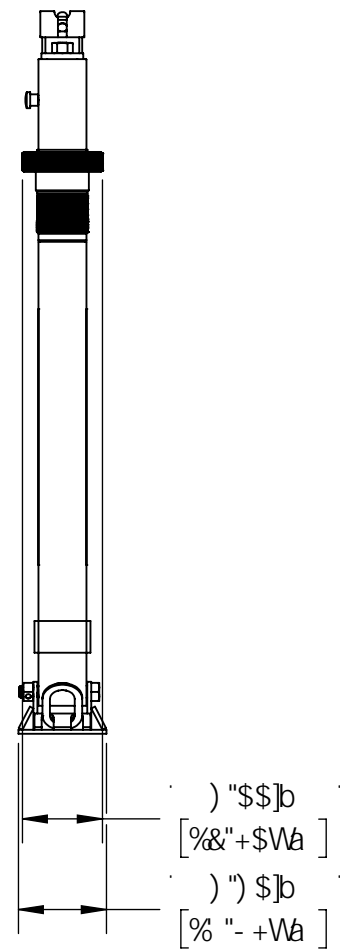
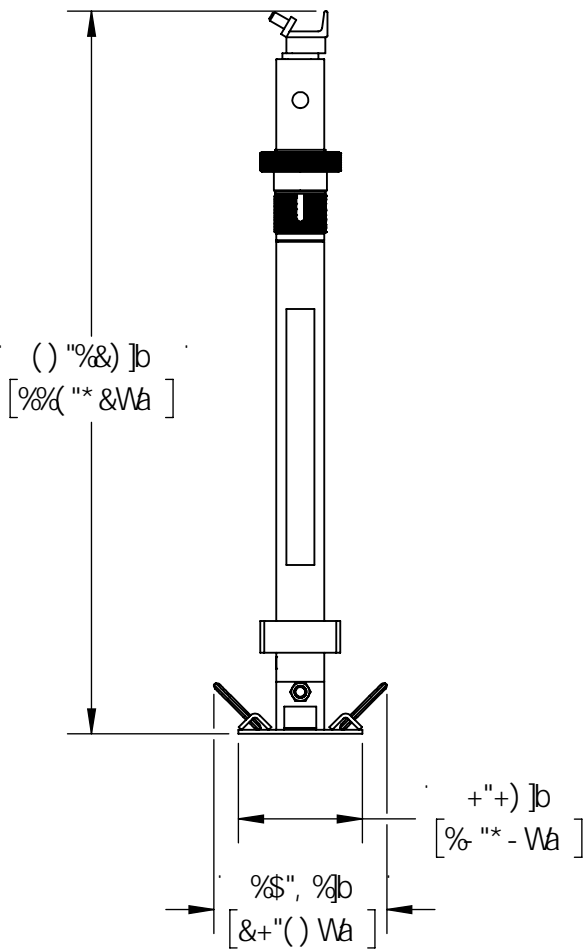

H97 <B=7 5@85H5 'G<99H

85H91 D85H98.
%&#% #&\$%+



H#&.
5 D9L '>5 7?

D5FHBC"
5 DL!>5 7?

@= HB; 'K @' * \$\$\$' @G#&+&%?; G

HF5J 9@'%&B# '\$(, '7 A

K 9= <H'+ '@G#%&'&)?; G

